

eve light switch

Quick Start Guide

Meet Eve Light Switch

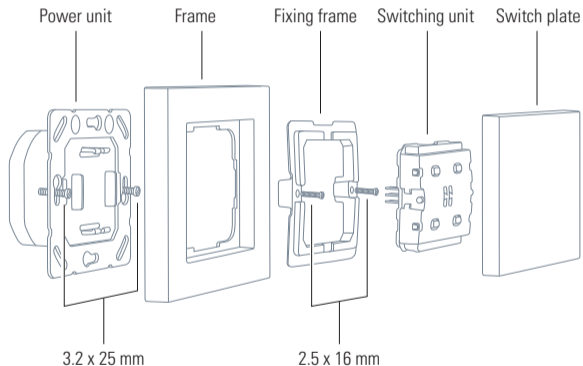

2

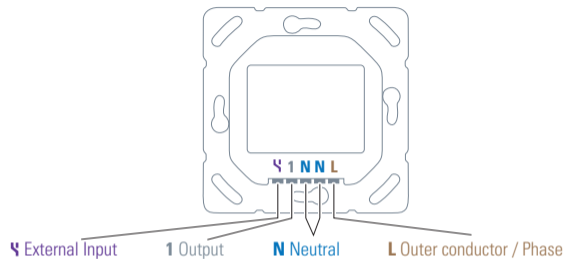

- Voltage: 230 V~ 50 / 60 Hz
- Switching capacity: 5 A
- Connection terminals: 1.5 mm² rigid wire
- External input: 230 V~
- Flush-mounted socket dimension: ø 60 mm, min. 35 mm depth
- Ambient temperature: -10 °C bis 50 °C
- Operating humidity: max. 85% rH, non-condensed
- Protection rating: IP30
- Frequency range: 2402 - 2480 MHz
- Max. RF Power (EIRP): < 4 dBm

3

Get Started



CAUTION - Risk of electric shock!

Only authorized electricians may connect, install and set up Eve Light Switch. Before installation, ensure the system is disconnected from the power supply!

Eve Light Switch is used to directly switch permanently connected electrical loads with a supply voltage of 230 V~. In particular, these include lighting and ventilation and exclude electric heaters, power outlets and machines of any kind.

Eve Light Switch is designed for use in household and similar fixed installations. Before installation, ensure suitability by reviewing the technical data and the operating conditions.

Eve Light Switch must not be used in conjunction with life-support systems or other devices that could put the life or health of humans and animals at risk or risk property damage.

Installation - Preparation

In your fuse box, switch off the fuse connected to your light switch. Switch the light switch on and off a few times to make sure that there is no current flowing.

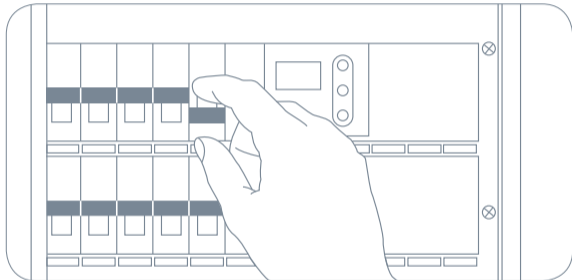

Installation - Rooms with a single light switch

1 Remove your current light switch

Loosen your existing light switch and pull it out. Note the current wiring and take a photo of it if necessary. You can usually tell which line is the current-carrying input (**L**) and which line leads to the light by the direction from which the cables are led into the box and by the inscription on your old light switch.



Eve Light Switch can only be installed if there is a neutral line (N, usually blue) in your outlet.

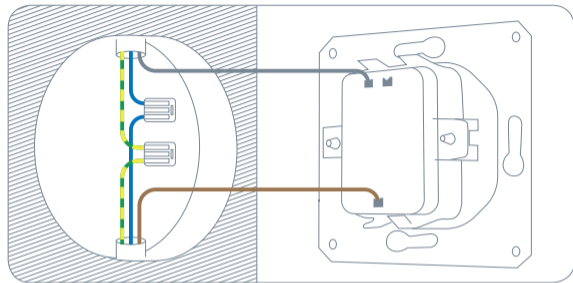

Remember which line is connected to the input on your old light switch (**L**), for example by marking it with adhesive tape. Then disconnect the existing wiring and remove your old light switch.

② Connect Eve Light Switch

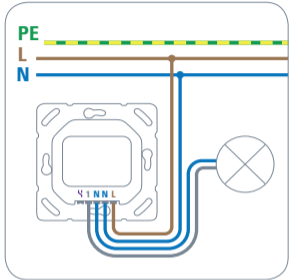

Eve Light Switch does not require a connection to a protective conductor / ground wire (PE, usually green yellow).

- **1:** Output (light)
- **N:** Neutral line
Eve Light Switch requires that a neutral line is connected. As an option, the second connection can be used to loop through the neutral line for a connected light, replacing a corresponding terminal. If the outlet is not equipped with a neutral line, Eve Light Switch is incompatible with this outlet.
- **L:** Outer conductor / phase (current-carrying line)
If you're not sure which line is live and which is connected to the light, just try one. Switching the input (L) and output (1) will not damage Eve Light Switch.

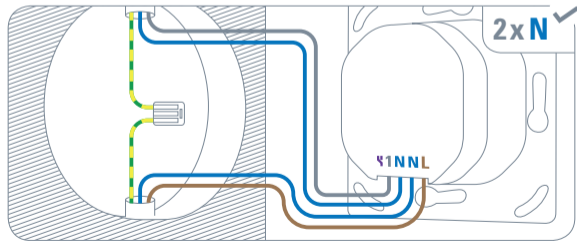
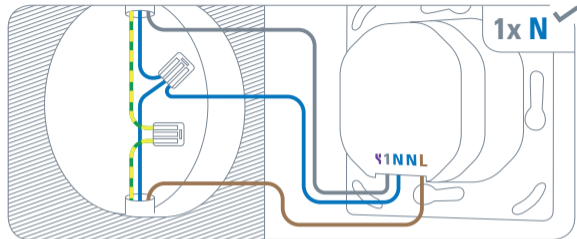

Installation - using substations

Use Eve Light Switch in rooms with several light switches at the end of the chain right before the light. Consult a specialist if you are unsure which lines are in use.

① Remove your current light switch

Loosen your existing light switch and pull it out. Note the current wiring and take a photo of it if necessary. You can usually tell which lines are coming from another light switch and which line leads to the light by the direction from which the cables are led into the outlet and by the inscription on your old light switch.



Eve Light Switch can only be installed if there is a neutral line (N, usually blue) in your outlet. Eve Light Switch also requires an independent, permanently live line (L, usually brown).

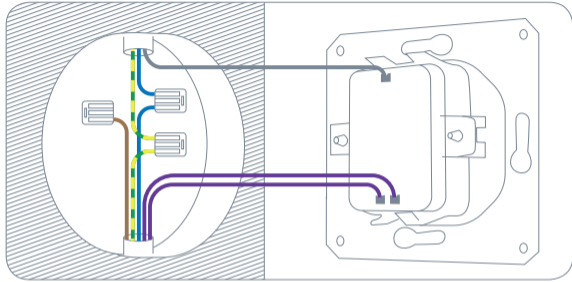

Remember which line goes where, for example by marking it with adhesive tape. Then disconnect the existing wiring and remove your old light switch.

② External input and its function

Eve Light Switch has an external input for compatibility with a variety of configurations in rooms with multiple light switches. After installation, you can use the Eve app to set whether Eve Light Switch should react to short impulses (push buttons) or constant changes (switches) at this input. Your light will be switched with each change.

Independent of the upstream switches, there is only one thing you need to keep in mind: when you press one of your other traditional buttons or switches, a current pulse (push button) or a change in the applied current (switch) should be triggered in the line connected to the external input. Eve Light Switch then takes over the switching of your light.



Since the unused cable can still carry electricity, please make sure that it is sufficiently isolated and stowed in the flush-mounted socket, for example with a terminal.

Since Eve Light Switch reacts to every change in the current at the external input, you only need one of the incoming lines of an existing alternating or cross-connection, as they alternately carry current when an upstream light switch is actuated.

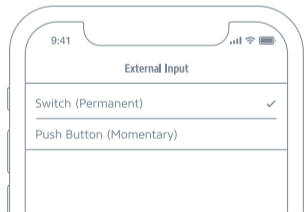
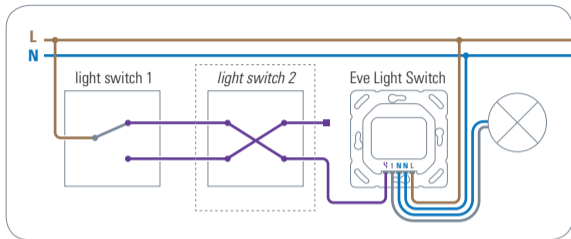

3 Connect Eve Light Switch

- **⚡**: External input (additional light switch)
- **N**: Neutral line
Eve Light Switch requires that a neutral line is connected. As an option, the second connection can be used to loop through the neutral line for a connected light, replacing a corresponding terminal. If the outlet is not equipped with a neutral line, Eve Light Switch is incompatible with this outlet.
- **1**: Output (light)
- **L**: Outer conductor / phase (current-carrying line)
Eve Light Switch requires an independent, permanently live line. If you're not sure which line is live and which is connected to the light, just try one. Switching the input (**L**) and output (**1**) will not damage Eve Light Switch.

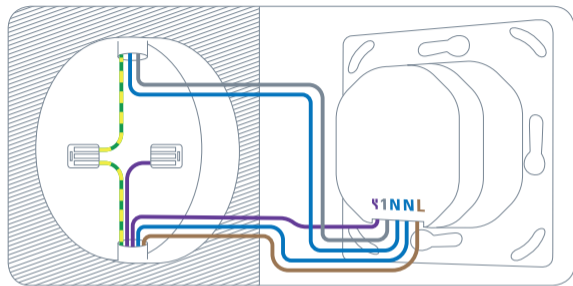

Eve Light Switch does not require a connection to a protective conductor / ground wire (PE, usually green/yellow).

Installation

- ① Place the power unit in the flush-mounted socket and secure it with the 3.2 x 25 mm screws (included).
- ② Place the supplied or your existing frame on the power unit and secure the fixing frame with the supplied screws.
- ③ Insert the switching unit and then press the switch plate onto it.
- ④ In your fuse box, switch on the fuse dedicated to the circuit of that light switch. You should now be able to switch your light on and off by pressing Eve Light Switch.



If your light does not react, the input (L) and output (1) lines may be reversed. Note the Eve Light Switch disassembly instructions and change the connection of these lines to continue.

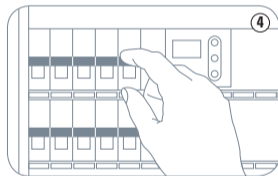
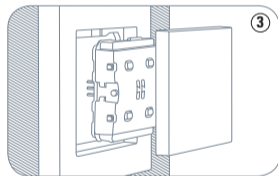
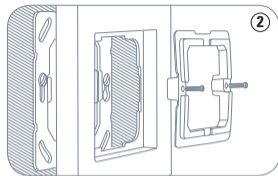
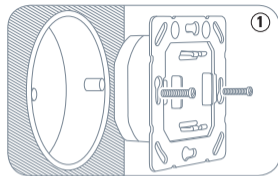

Setup

- Download the Eve app from the App Store.
- Open the Eve app and tap Add Accessories. Eve will now guide you through the setup process.

If you already have Eve set up, open Eve settings and add Eve Light Switch.

🔍 Eve



To add Eve Light Switch, use the HomeKit code on the back of this manual.

Enjoy

Switch on your light using the app or a Siri voice command.

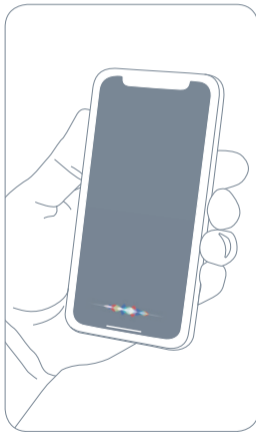

You can also switch on your light directly via the Eve Light Switch.

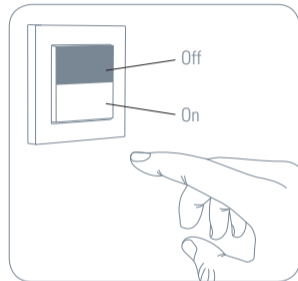

If you have mounted Eve Light Switch the other way around, you can flip the on and off orientation in the accessory settings.

Reset

- ① Remove the switch plate by pulling the center plate evenly from both sides.

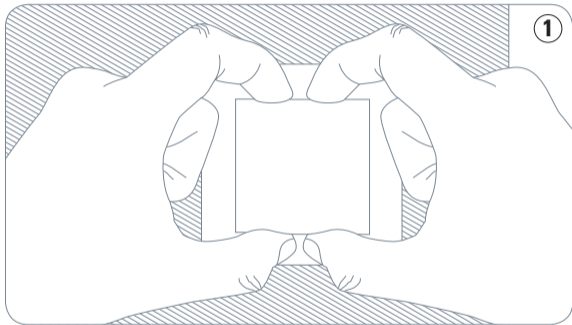

- ② Press both left buttons simultaneously for 10 seconds.

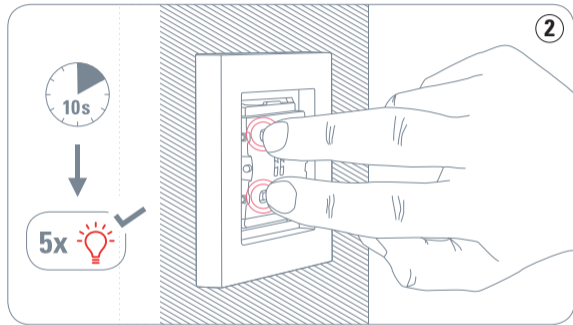

Disassembly

- ① In your fuse box, switch off the fuse connected to your light switch.
- ② Make sure that there is no current flowing by switching Eve Light Switch on and off a few times.
- ③ Remove the switch plate by pulling the center plate evenly from both sides.
- ④ Remove the switching unit by inserting a screwdriver into each of the corners and levering it out evenly.
- ⑤ Loosen the screws, remove the fixing unit and remove the frame.
- ⑥ You can now remove the power unit from your flush-mounted socket and disconnect the cables.

